

TA8008 octal Fast Pulse / Timing Pre-amplifier

DC coupled, low noise, high bandwidth



A unique feature for such high speed amplifiers is the DC coupling. DC coupling avoids count rate effects due to non DC balanced pulse trains and the corresponding charging of coupling capacitors.

SPECIFICATIONS

Material:

Case: extruded aluminum sheath
Al Mg Si 0.5
Lid: die cast, GD-Al Si 12
Size: 214 x 78 x 122/128 mm

Power Requirements:

Connector: 2.1 mm center pin
Supply Voltage: nominal +12V
voltage range +10 ... +18V
Supply Power: 18W
False polarity protection

Absolute maximum ratings:

Supply: 36V (100ms max.)
Signal input: +/- 1.8V, +/- 140mA
ESD rating: 2000V HBM, 200V MM

Inputs: SMA, 50 Ohm, DC coupled

Outputs: SMA, low impedance, DC coupled
50Ω output option available
 $V_{OUT} = +/- 1.3V$ max.
 $I_{OUT} = +/- 150mA$ max.

Accessories:

- External wall power supply (included)
- L-clips (AB-WL3) for wall-/screw -mounting (optional)

Available Options:

- 50 Ω output impedance
- BWL – bandwidth limited (AM83xx)
- Input/Output AC coupling

FEATURES

- 8 amplifiers in a single case
- **User selectable combination of 8 amplifiers** out of the complete pool of 9 different AM8000 amplifier modules
- DC coupled
- Small signal bandwidths up-to 2.2GHz available, model dependent
- Voltage gains from 14dB (x5) to 46dB (x200), model dependent
- Non-inverting closed loop OP-Amp design
- Single +12V power supply
- Low and very low noise models
- High output drive
- Bandwidth limited (BWL) options available for further improved noise performance
- Offset adjustment

APPLICATIONS

- Pre-amps for ultra fast detectors (MCP, PMT, ...)
- Oscilloscope and transient recorder pre-amps
- High precision Time-of-Flight
- Photon-/Ion- counting
- Wideband signal processing

DESCRIPTION

The TA8008 octal timing amplifier comprises a common power supply casing that is populated with a user selectable choice of 8 amplifier modules AM8000.

The pool of available AM8000 fast timing amplifiers consists of 3 basic type families:

- low noise, high bandwidth AM81xx
- high bandwidth, high gain AM82xx
- very low noise AM83xx

Each AM83xx model is also available with a bandwidth limited (BWL) option which further reduces the noise floor.

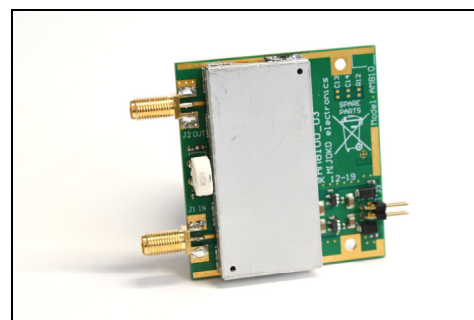

TA8008 octal Fast Pulse / Timing Preamplifier

DC coupled, low noise, high bandwidth

Amplifier Modules (AM8000) Overview

Family	Type	Nominal Gain [V/V]	Nominal Gain [dB]	Small Signal Bandwidth (-3dB)	50 Ohm Output Option: Small Signal Bandwidth (-3dB)
				(0) (1)	(0) (1)
Low Noise, High Bandwidth	AM8101	5	14dB	2200MHz	2800MHz
	AM8102	10	20dB	1700MHz	2100MHz
High Bandwidth, High Gain	AM8201	20	26dB	2000MHz	2280MHz
	AM8202	40	32dB	1700MHz	2000MHz
	AM8203	80	38dB	1500MHz	1700MHz
Very Low Noise	AM8301 BWL ⁽⁶⁾	10	20dB	170MHz	200MHz
	AM8301	10	20dB	710MHz	850MHz
	AM8302 BWL ⁽⁶⁾	50	34dB	245MHz	245MHz
	AM8302	50	34dB	1000MHz	1000MHz
	AM8303 BWL ⁽⁶⁾	100	40dB	245MHz	245MHz
	AM8303	100	40dB	950MHz	990MHz
	AM8304 BWL ⁽⁶⁾	200	46dB	110MHz	110MHz
	AM8304	200	46dB	400MHz	400MHz

AM8000 Comparison and Selection Chart

Type	Nominal Gain [V/V]	Nominal Gain [dB]	Small Signal Bandwidth (-3dB)	Gain Flatness	Peaking (100ps Rise Time Input Pulse)	Noise Figure (100MHz)	Input Referred Broadband Noise (DC ... 12.5GHz)		Input Referred LF Noise (20Hz ... 1MHz)
			(0) (1)	(0) (1)	(0) (2)		(3) (4)	(4)	(5)
AM8101	5	14dB	2200MHz	0.00dB	0%	16dB	123.0µV _{rms}	1.255mV _{p-p}	5.4µV _{rms}
AM8102	10	20dB	1700MHz	0.00dB	0%	16dB	95.4µV _{rms}	1.033mV _{p-p}	4.1µV _{rms}
AM8301	10	20dB	710MHz	0.00dB	6%	8dB	41.3µV _{rms}	0.802mV _{p-p}	3.3µV _{rms}
AM8301 BWL ⁽⁶⁾	10	20dB	170MHz	0.00dB	0%		26.7µV _{rms}	0.230mV _{p-p}	2.1µV _{rms}
AM8201	20	26dB	2000MHz	0.29dB	7%	17dB	135.1µV _{rms}	1.497mV _{p-p}	4.6µV _{rms}
AM8202	40	32dB	1700MHz	0.32dB	7%	17dB	107.3µV _{rms}	1.253mV _{p-p}	3.3µV _{rms}
AM8302	50	34dB	1000MHz	0.22dB	9%		51.7µV _{rms}	0.615mV _{p-p}	1.0µV _{rms}
AM8302 BWL ⁽⁶⁾	50	34dB	245MHz	0.00dB	0%		35.8µV _{rms}	0.369mV _{p-p}	0.8µV _{rms}
AM8203	80	38dB	1500MHz	0.36dB	7%	17dB	103.8µV _{rms}	1.268mV _{p-p}	3.8µV _{rms}
AM8303	100	40dB	950MHz	0.12dB	8%		48.3µV _{rms}	0.525mV _{p-p}	1.0µV _{rms}
AM8303 BWL ⁽⁶⁾	100	40dB	245MHz	0.00dB	0%		30.7µV _{rms}	0.340mV _{p-p}	0.9µV _{rms}
AM8304	200	46dB	400MHz	0.00dB	0%		26.7µV _{rms}	0.423mV _{p-p}	1.2µV _{rms}
AM8304 BWL ⁽⁶⁾	200	46dB	110MHz	0.00dB	0%		18.6µV _{rms}	0.206mV _{p-p}	1.1µV _{rms}

(0) Simulation Results

(1) Signal input: sine wave = 200mV_{eff} / "nominal Gain"

(2) Output Pulse Height approx. 200mV_{p-p}, Input Rise Time 100ps

(3) defined as $RMS\Delta = \sigma$ = standard deviation, ref. scope pictures of output noise voltages below

(4) in 40 minutes accumulated with a 12.5GHz sampling head, ref. scope pictures of output noise voltages below

(5) measured with a HP3455A True RMS Voltmeter, this is mostly the 1/f noise

(6) BWL = Bandwidth limited option (with improved noise performance)

TA8008 octal Fast Pulse / Timing Preampifier

DC coupled, low noise, high bandwidth

Simulated Voltage Gain

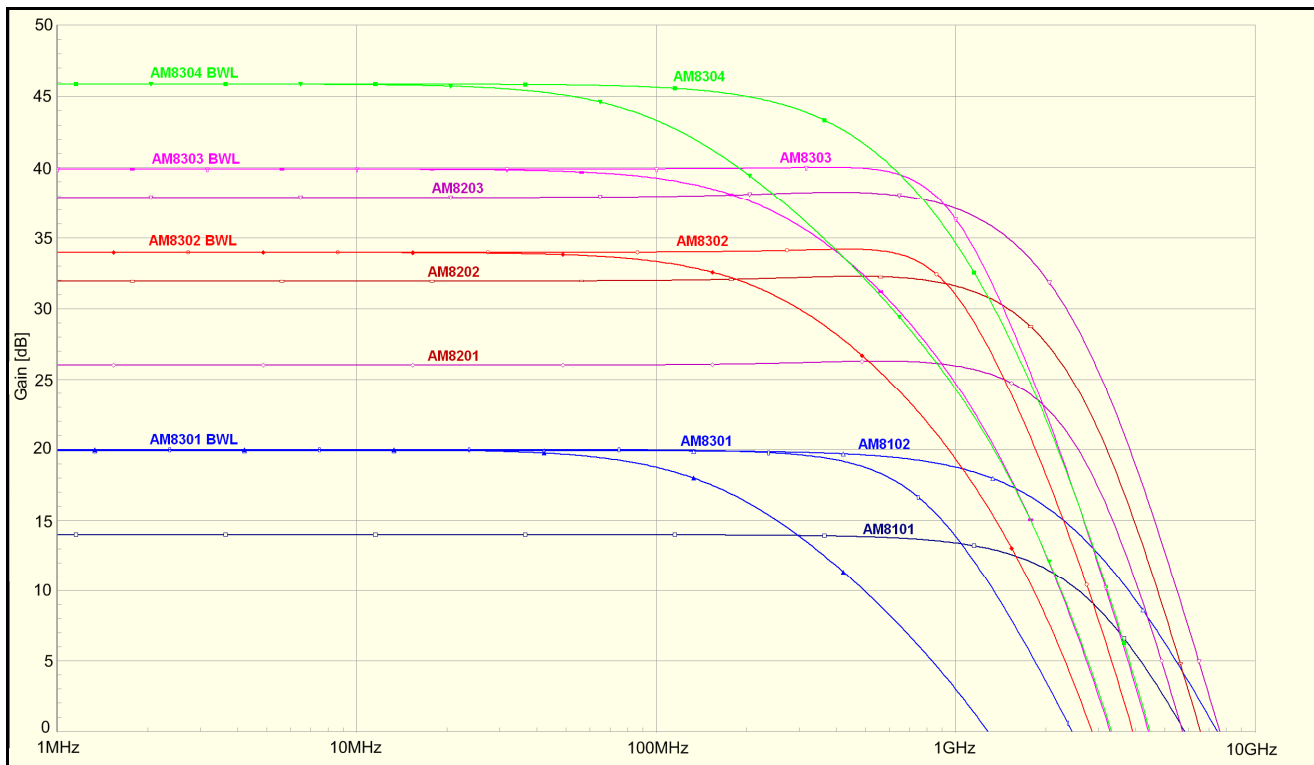

(*) 200mVeff output signal into 50Ω load

Simulated Pulse Response

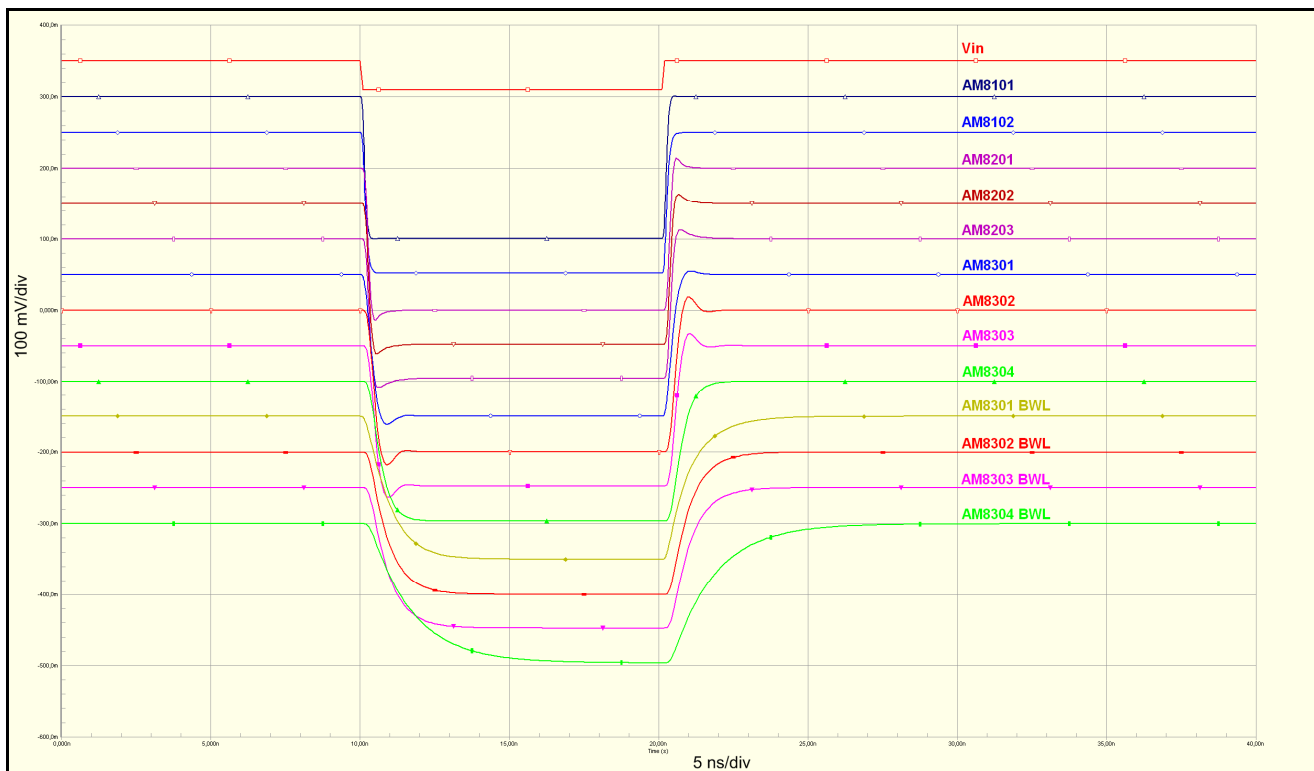

(*) Signals are voltage shifted for better comparison

(**) Input signal to each amplifier is scaled according the gain

TA8008 octal Fast Pulse / Timing Preamplifier

DC coupled, low noise, high bandwidth

Pulse Response

In the following scope pictures you see the pulse response for negative output signals starting at 0V and falling down to -400mV. The input pulse amplitudes are selected according the gain of each amplifier.

- 0V to -400mV falling edge output

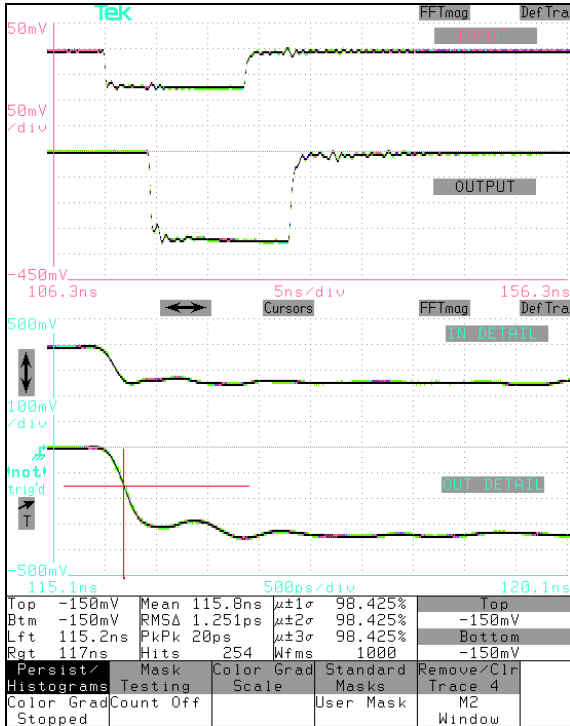

AM8101 (x5), Input 50mV/div, Output 100mV/div

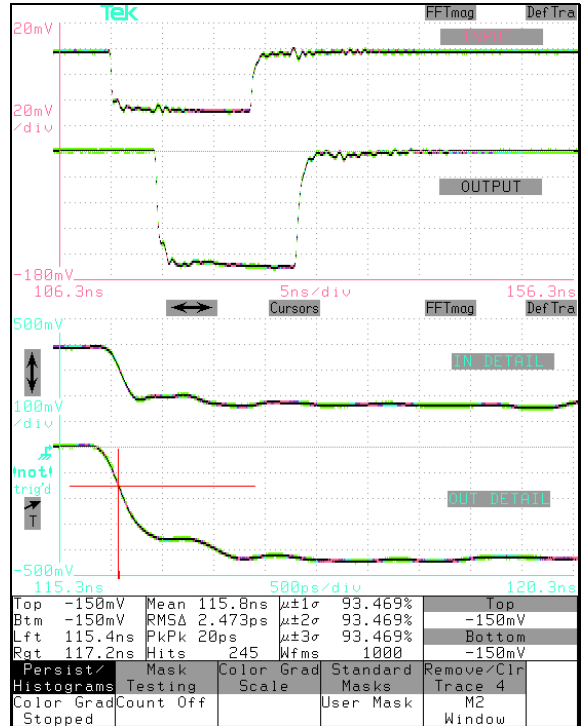

AM8102 (x10), Input 20mV/div, Output 100mV/div

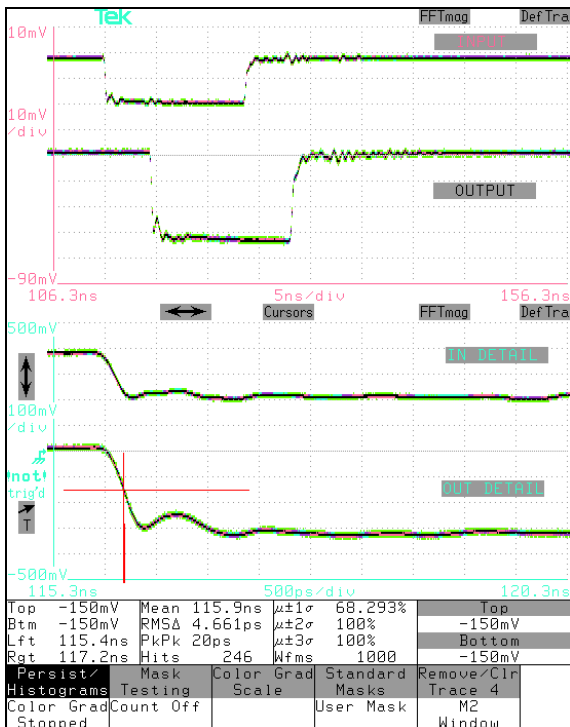

AM8201 (x20), Input 10mV/div, Output 100mV/div

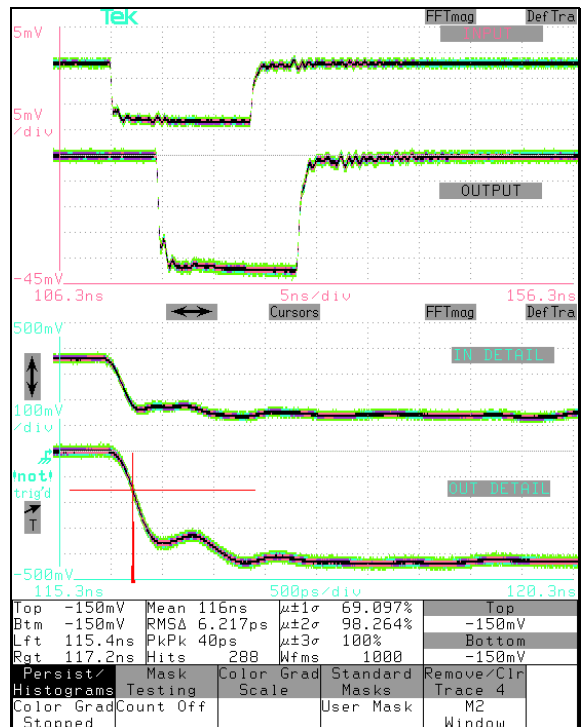

AM8202 (x40), Input 5mV/div, Output 100mV/div

TA8008 octal Fast Pulse / Timing Preamplifier

DC coupled, low noise, high bandwidth

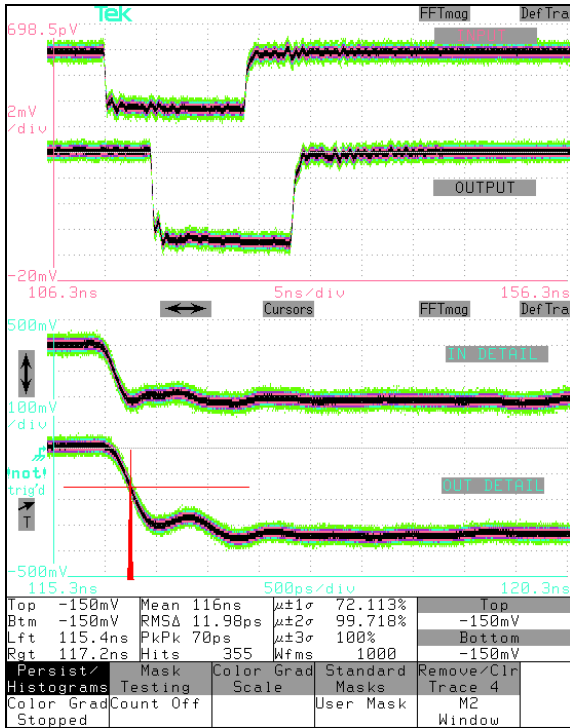

AM8203 (x80), Input 2mV/div, Output 100mV/div

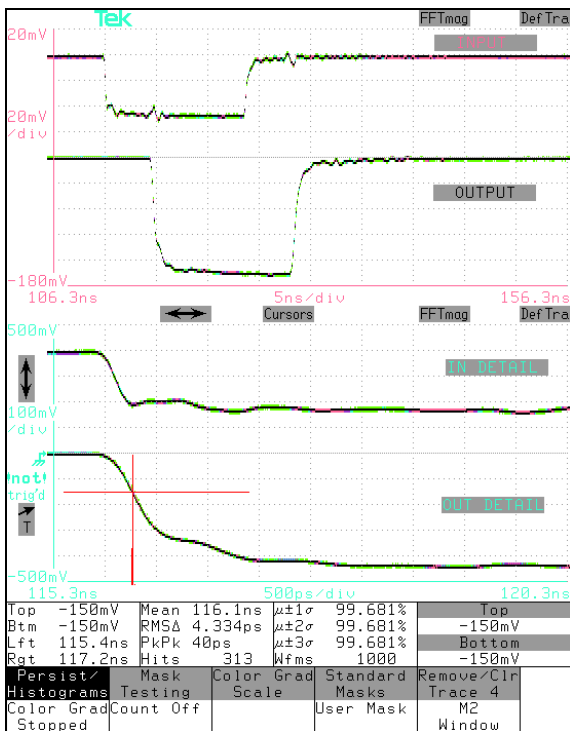

AM8301 (x10), Input 20mV/div, Output 100mV/div

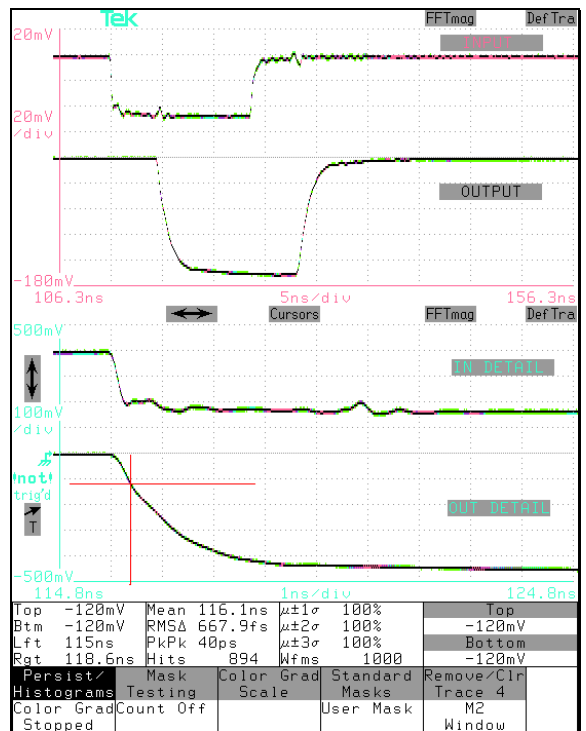

AM8301 BWL (x10), Input 20mV/div, Output 100mV/div

TA8008 octal Fast Pulse / Timing Preamplifier

DC coupled, low noise, high bandwidth

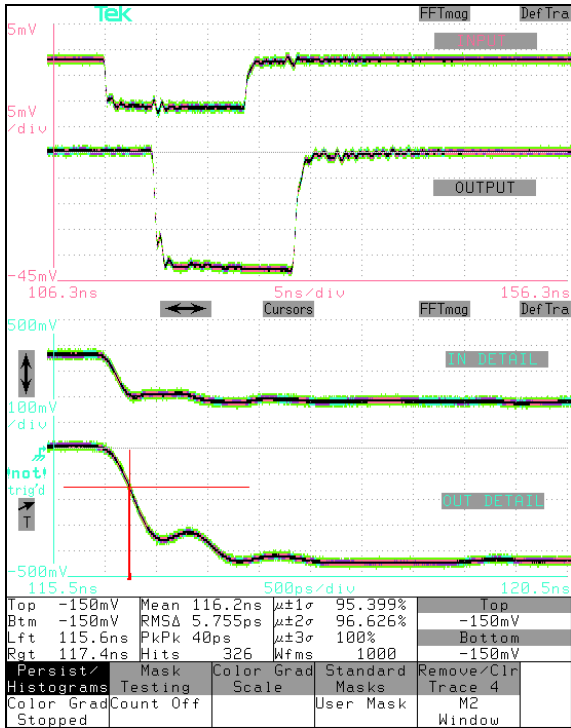

AM8302 (x50), Input 5mV/div, Output 100mV/div

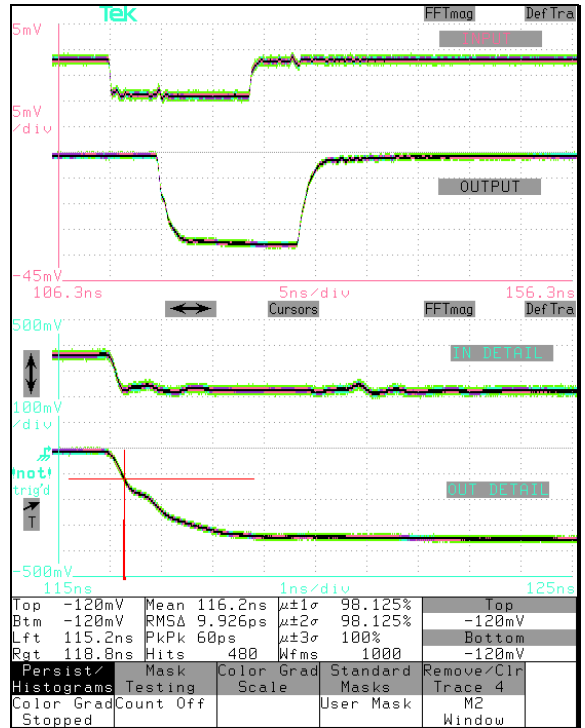

AM8302 BWL (x50), Input 5mV/div, Output 100mV/div

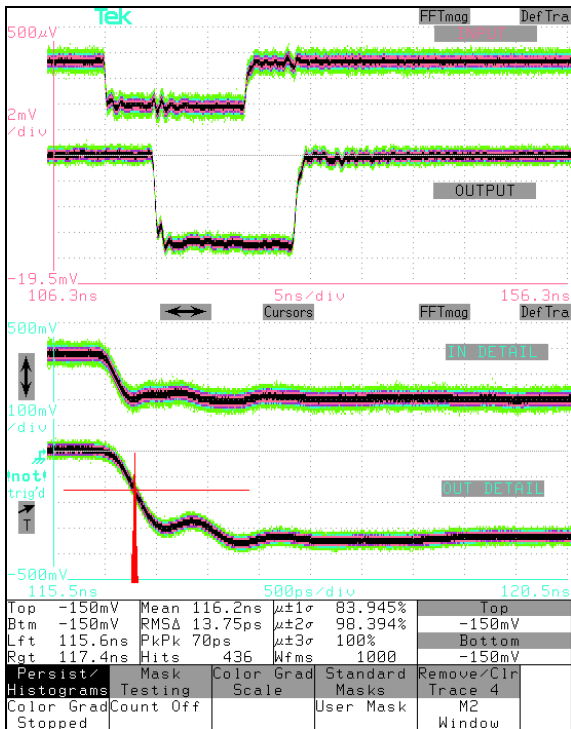

AM8303 (x100), Input 2mV/div, Output 100mV/div

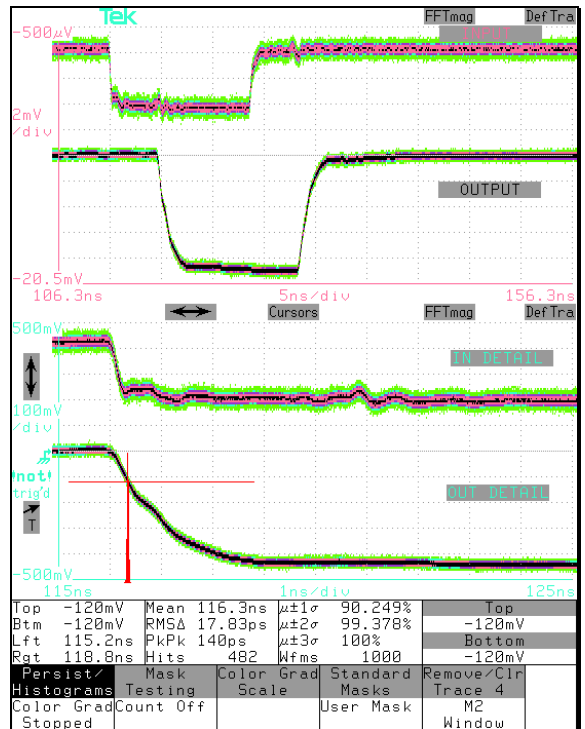

AM8303 BWL (x100), Input 2mV/div, Output 100mV/div

TA8008 octal Fast Pulse / Timing Preamplifier

DC coupled, low noise, high bandwidth

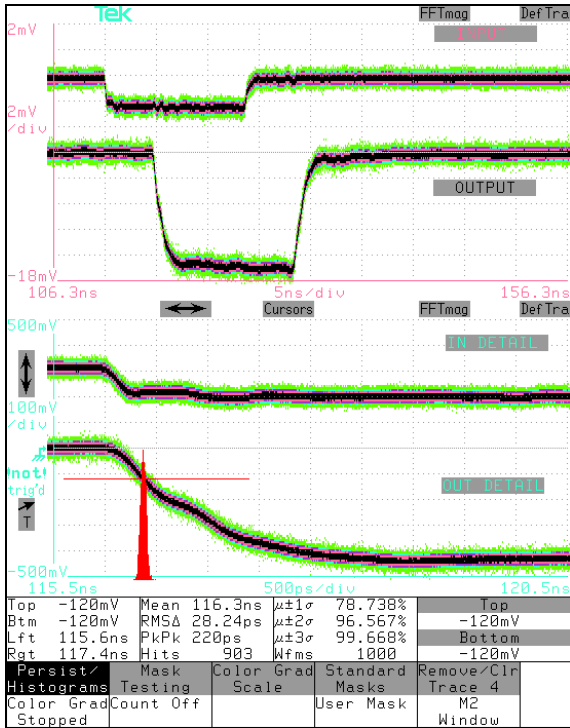

AM8304 (x200), Input 2mV/div, Output 100mV/div

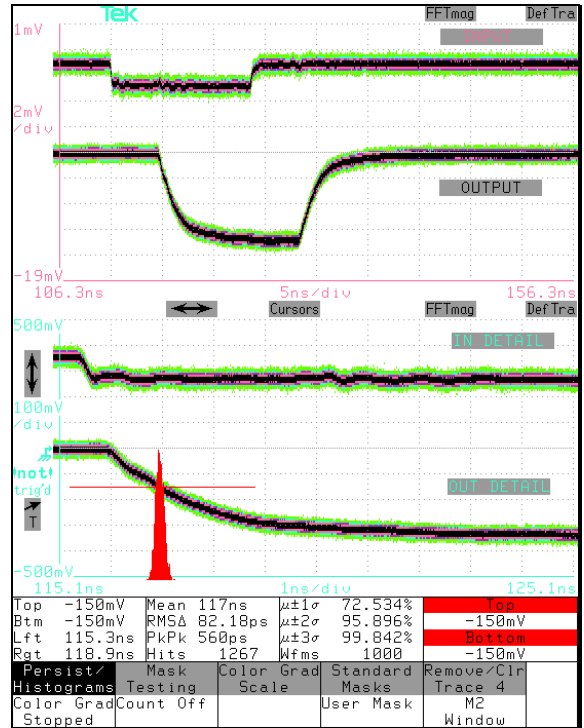

AM8304 BWL (x200), Input 2mV/div, Output 100mV/div

The lower window of each plot shows details of the corresponding signals in the upper window. There is also a (red colored) histogram of the output signal jitter at a -120mV or -150mV threshold. The jitter's Peak-to-Peak value is visible at "PkPk" and its standard deviation in the "RMSΔ" readout.

This jitter histogram gives a good indication of the timing accuracy and resolution that can be expected.

And, one can very well see that the optimum threshold setting for timing measurements is often not at half of the signal's amplitude but at some other level not too far from idle voltage where the slew rate is at maximum.

NOTE: The timescale for the lower windows (detail view) is generally 500ps/div and 1ns/div for the BWL (bandwidth limited) options.

TA8008 octal Fast Pulse / Timing Preamplifier

DC coupled, low noise, high bandwidth

Noise Voltage

First, let me give a short introduction on the common noise specifications of amplifiers and their specific meaning. Generally, random noise voltages add algebraically. In other words, you can only add noise power or the square of the noise voltages. The noise voltages of an amplifier can be visualized over frequency in a noise density distribution curve expressed in "Volts per root Hertz" (V/\sqrt{Hz}). This is typically flat over many decades of frequency and often increasing for low frequencies (typ. <100kHz...1MHz) at an $1/f$ rate. The total noise power is determined by squaring this noise density curve and integrating it over the used frequency range. Metaphorically speaking, it is the area below the V^2/Hz density curve. Important is, that the $1/f$ noise can be safely neglected when the amplifier bandwidth is high compared to the $1/f$ corner. Thus, ac-coupling with a low frequency cut-off below 1MHz will not improve the total noise.

Most often, noise is given input referred. This means, the noise voltage at the output is divided by the amplifier gain. Thus, it is looked at like a noise source at the input of a noise free amplifier.

In datasheets you often find a "total input referred noise density" value at a given frequency (e.g. AM8102: $2.5\text{ nV}/\sqrt{Hz}$ at 1MHz).

Then, there is a "total low frequency noise" (e.g. AM8102: $2.5\mu\text{V}_{\text{rms}}$ in a 20Hz...1MHz bandwidth). This is mostly a measure for the $1/f$ noise.

"NOISE FIGURE", NF is the logarithm ratio of the output and input signal-to-noise ratios at a given frequency (e.g. AM8202: NF = 16dB at 100MHz). So, it is a measure on how the signal-to-noise power ratio is worsened by the amplifier or how much noise power is added by the amplifier itself. Note that it is very much dependent on source resistance.

A good introduction to noise specs is "Noise Specs Confusing?", National Semiconductor application note AN104, available for download at the website of National Semiconductor.

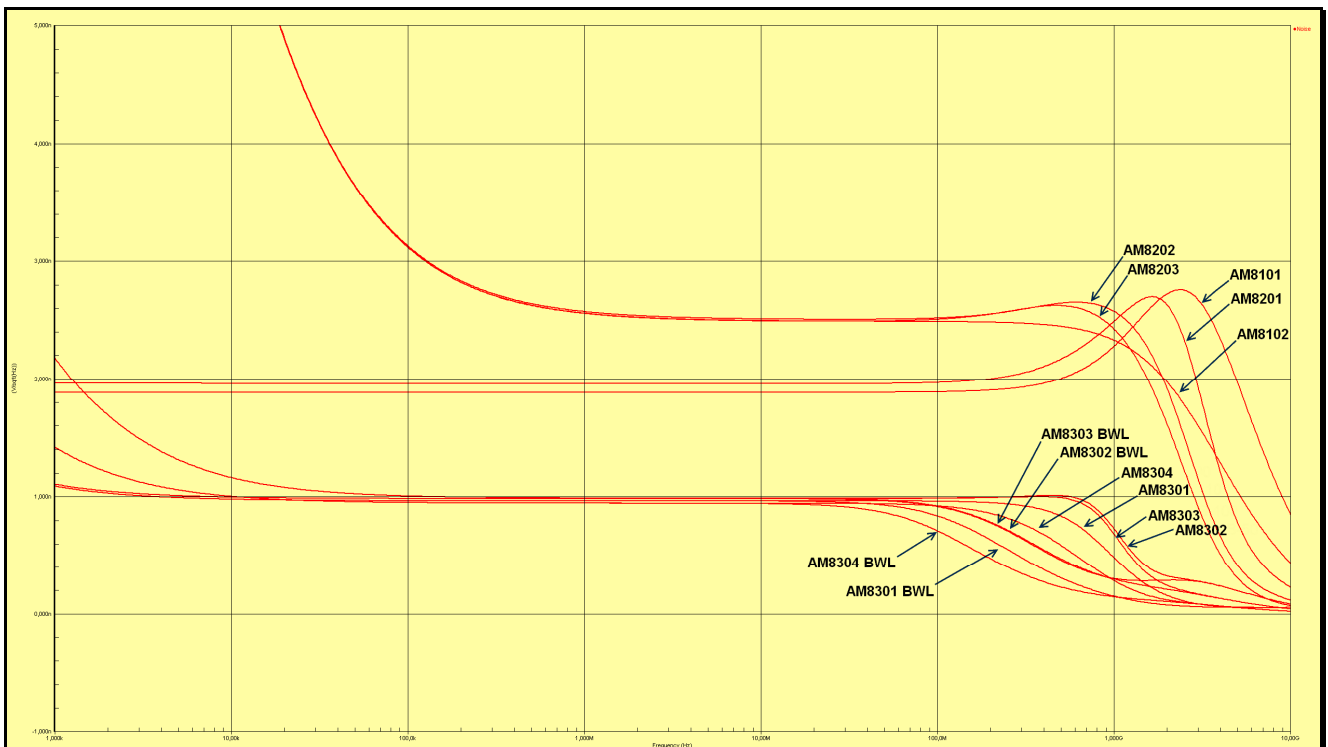

Simulation Results of Input referred Voltage Noise Density of AM8xxx Amplifier Modules

TA8008 octal Fast Pulse / Timing Preamplifier

DC coupled, low noise, high bandwidth

- Max. Output Noise Voltage

Normally the noise is given input referred, so to speak, it can be compared to the source signal levels. For timing applications it is often more depicting to plot the total output noise of an amplifier.

In the following scope pictures the output noise voltage of our AM8000 amplifiers is accumulated over 10,000 waveforms corresponding to about 40 minutes of measurement time. Used was a TEK11801B digital sampling scope with a 12.5GHz sampling head. Thus, the displayed noise voltage is accumulated over a long period and also over the full bandwidth of each amplifier. The AM8000's inputs were shortened, i.e. $Z_{Source} = 0\Omega$.

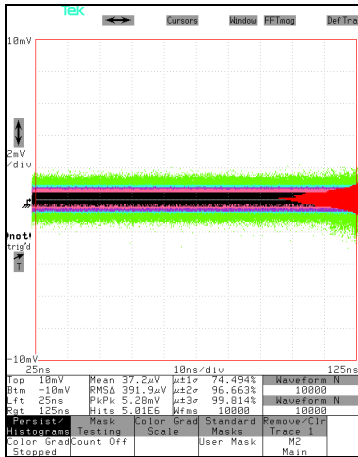

Sampling Head alone, 2mV/div

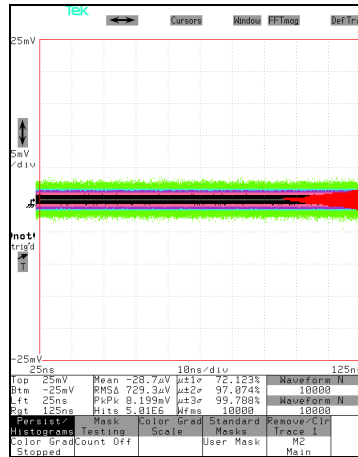

AM8101 (x5), 5mV/div

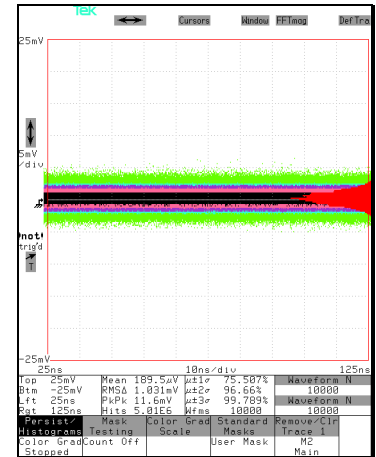

AM8102 (x10), 5mV/div

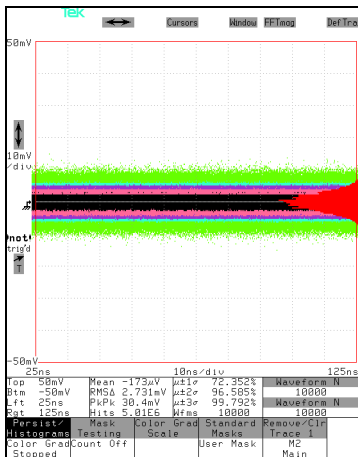

AM8201 (x20), 10mV/div

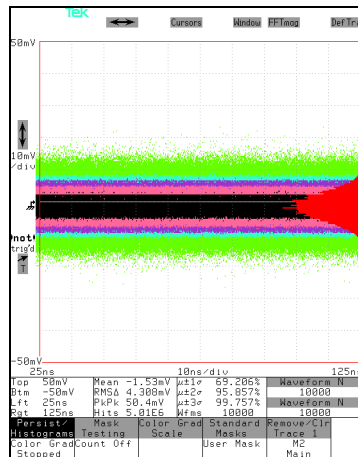

AM8202 (x40), 10mV/div

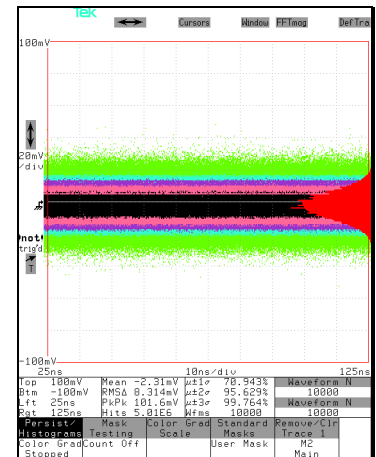

AM8203 (x80), 20mV/div

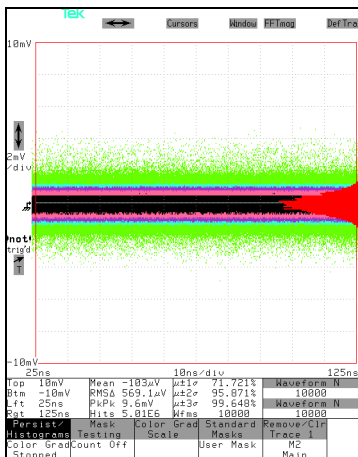

AM8301 (x10), 5mV/div

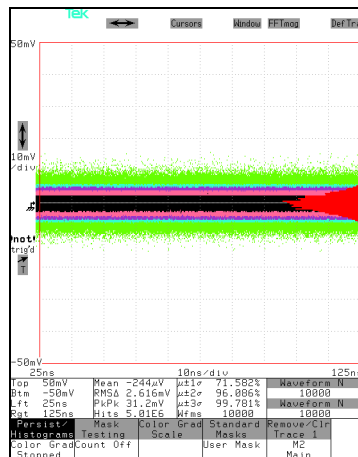

AM8302 (x50), 10mV/div

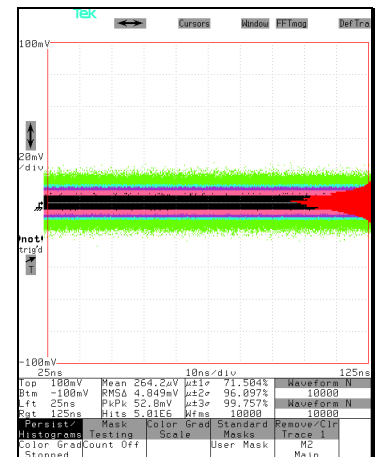

AM8303 (x100), 20mV/div

TA8008 octal Fast Pulse / Timing Preamplifier

DC coupled, low noise, high bandwidth

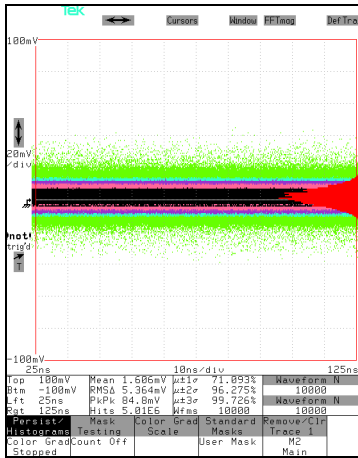

AM8304 (x200), 20mV/div

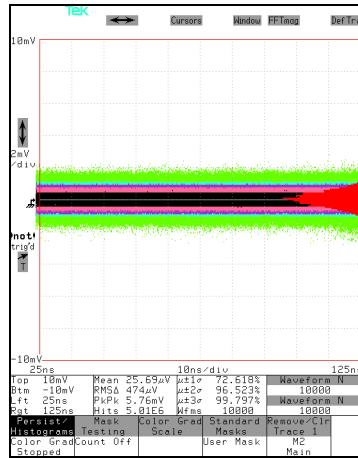

AM8301 BWL (x10), 5mV/div

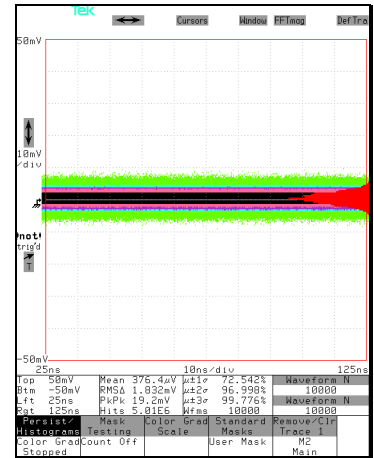

AM8302 BWL (x50), 10mV/div

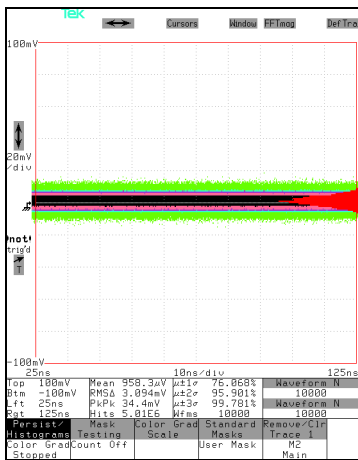

AM8303 BWL (x100), 20mV/div

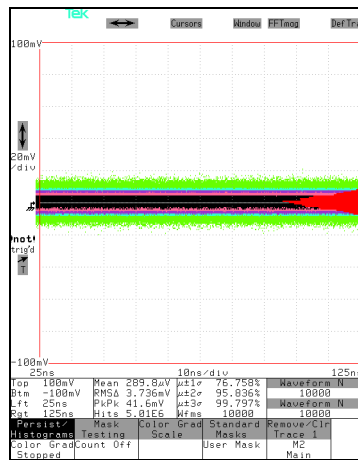

AM8304 BWL (x200), 20mV/div

On the right side of each plot you can see a (red colored) histogram of all the voltage samples in the respective picture. This gives the probability distribution of the noise voltage levels. And, you can find some analysis data of the respective voltage distribution: **Mean** = average value, **RMSΔ** = σ = standard deviation, **PkPk** = Peak-to-Peak voltage = max. – min. sample voltage, **$\mu \pm 1\sigma$** = percentage of samples that fall within ± 1 standard deviation of the mean ($\pm 2\sigma$, $\pm 3\sigma$ respectively).

TA8008 octal Fast Pulse / Timing Preamplifier

DC coupled, low noise, high bandwidth

Simplified Circuit Diagrams

- AM8101, 8102:

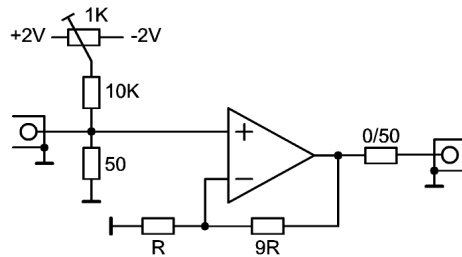

- AM8201, 8202, 8203:

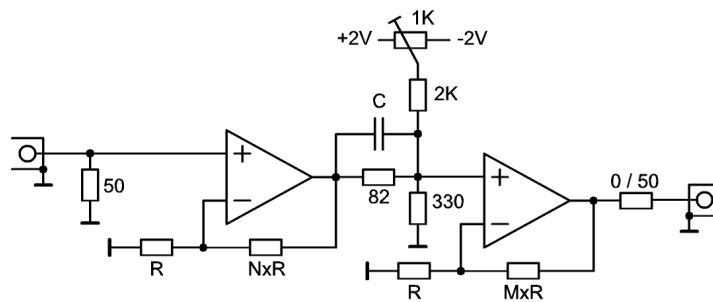

- AM8301:

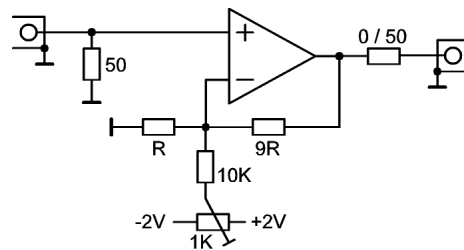

- AM8302, 8303, 8304:

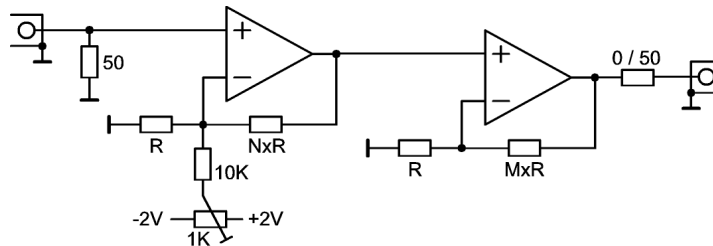

WARNING: The amplifiers have no thermal shutdown. Thus, be careful when connecting the output to loads less than 50 Ohms (**do not shorten the output!**).

TA8008 octal Fast Pulse / Timing Preampifier

DC coupled, low noise, high bandwidth

For ordering use the configuration form below:

TA8008 Configuration Form											V 1.1
<p>Select 1 amplifier module per channel. 8 modules in total. And, for each channel the corresponding option, if wanted.</p> <p>Any combination of module and channel no. is applicable.</p>											
		Chn.No.:	1	2	3	4	5	6	7	8	ALL
Module Type	Gain	(tick 1 module box per channel column or ALL)									(equal in all channels)
AM8101	x5										
AM8102	x10										
AM8201	x20										
AM8202	x40										
AM8203	x80										
AM8301	x10										
AM8302	x50										
AM8303	x100										
AM8304	x200										
Options											
50 Ohm Output											
Bandwidth Limit	(AM83xx only)										
AC Coupling											