

# TA2000B-x

GHz Fast Pulse / Timing Preamplifier

## User Manual

© copyright FAST ComTec GmbH  
Grünwalder Weg 28a, D-82041 Oberhaching  
Germany



## Warranty

Equipment manufactured by FAST ComTec GmbH is warranted against defects in materials and workmanship for a period of twelve months from date of shipment, provided that the equipment has been used in a proper manner as detailed in the instructions manuals. During the warranty period, repairs or replacement will be made to FAST ComTec's discretion on a return to factory basis. The transportation costs, including insurance to FAST ComTec is the responsibility of the customer except for defects discovered within 30 days after receipt of the equipment, where shipping expense will be paid by FAST ComTec.

**Copyright © 1988 - 2011 FAST ComTec GmbH,  
D-82041 Oberhaching, Germany  
All rights reserved.**

This manual contains proprietary information; no part of it may be reproduced by any means without prior written permission of FAST ComTec, Grünwalder Weg 28a, D-82041 Oberhaching, Germany. Tel: ++49 89 66518050, FAX: ++49 89 66518040.

The information in this manual describes the hardware and the software as accurately as possible, but is subject to change without notice.

FAST ComTec GmbH, Grünwalder Weg 28a, D-82041 Oberhaching, Germany  
Tel. +49(0)89-66518050, Geschäftsführer Dr. Wolfgang Wagner,  
Handelsregister München HRB 73004

## Table of Contents

1. Description .....	1-1
2. Specifications .....	2-1
2.1. Absolute maximum ratings.....	2-1
2.2. Technical data.....	2-1
2.3. Diagrams.....	2-2
2.3.1. TA2000B-1 (x20) pulse response .....	2-2
2.3.2. TA2000B-2 (x40) pulse response .....	2-3
2.3.3. TA2000B-3 (x80) pulse response .....	2-4
2.3.4. Simulated frequency response .....	2-5
2.4. Power requirements .....	2-6
2.5. Metal case.....	2-6
2.6. Accessories.....	2-6
2.7. Available options .....	2-6

## Table of Figures

Fig. 1.1: Simplified schematic .....	1-1
Fig. 1.2: Comparison chart.....	1-1
Fig. 2.1: TA2000B-1, (0Ω , 200mV <sub>P-P</sub> output).....	2-2
Fig. 2.2: TA2000B-1 (50Ω option, 200mV <sub>P-P</sub> output) .....	2-2
Fig. 2.3: TA2000B-1 (0Ω, 800mV <sub>P-P</sub> negative output pulse) .....	2-2
Fig. 2.4: TA2000B-1 (50Ω option, 800mV <sub>P-P</sub> negative output pulse).....	2-2
Fig. 2.5: TA2000B-2 (0Ω, 200mV <sub>P-P</sub> output) .....	2-3
Fig. 2.6: TA2000B-2 (50Ω option, 200mV <sub>P-P</sub> output) .....	2-3
Fig. 2.7: TA2000B-2 (0Ω, 800mV <sub>P-P</sub> negative pulse).....	2-3
Fig. 2.8: TA2000B-2 (50Ω option, 800mV <sub>P-P</sub> negative output pulse).....	2-3
Fig. 2.9: TA2000B-3 (0Ω, 200mV <sub>P-P</sub> output) .....	2-4
Fig. 2.10: TA2000B-3 (50Ω option, 200mV <sub>P-P</sub> output) .....	2-4
Fig. 2.11: TA2000B-3 (0Ω, 800mV <sub>P-P</sub> negative pulse).....	2-4
Fig. 2.12: TA2000B-3 (x50Ω option, 800mV <sub>P-P</sub> negative output pulse) .....	2-4
Fig. 2.13: Simulated frequency response of all TAx models.....	2-5

## 1. Description

The TA2000B-x comprises a series of fast preamplifiers with model dependent voltage gains of 20, 40 or 80 V/V and corresponding small signal bandwidths of 2.0, 1.7 or 1.5 GHz respectively.

A unique feature for such high speed amplifiers is DC coupling. DC coupling avoids count rate effects due to non DC balanced pulse trains and the corresponding charging of coupling capacitors.

Basically the TA2000B is a non inverting, closed loop, voltage mode, two-stage operational amplifier design.

Input offset adjustment is provided. Please be aware that the offset adjustment is connected to the non-inverting input of the second amplifier stage. Thus, a small input signal dependency exists. The input related adjustment range is approximately  $\geq \pm 5$  mV.

**WARNING:** The amplifier has no thermal shutdown. Thus, be careful when connecting the output to loads less than 50 Ohms (**do not shorten the output!**).

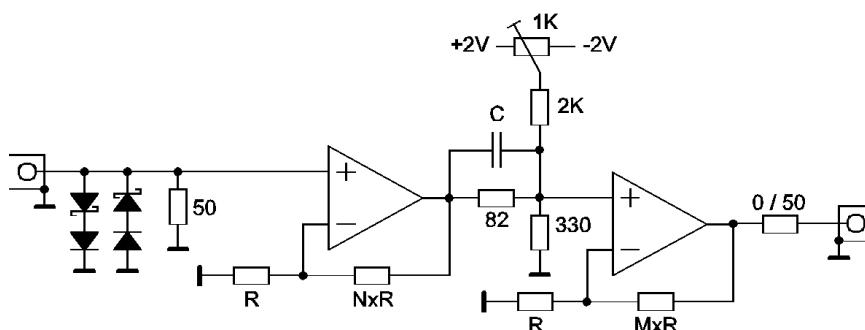

Fig. 1.1: Simplified schematic

Type	Nominal Gain [V/V]	Nominal Gain [dB]	Small Signal Bandwidth (-3dB)	Gain Flatness	Peaking (100ps Rise Time Input Pulse)	Input Referred Noise (20Hz...1MHz)	50 Ohm Output Option: Gain into 50 Ohm	50 Ohm Output Option: Small Signal Bandwidth (-3dB)
			(0) (1)	(0) (1)	(0) (2)	(3)		(0) (2)
TA2000B-1	20	26dB	2.00GHz	0,29dB	7%	3.7 $\mu$ Vrms	10	2.28GHz
TA2000B-2	40	32dB	1.74GHz	0,32dB	7%	4.0 $\mu$ Vrms	20	1.98GHz
TA2000B-3	80	38dB	1.53GHz	0,36dB	7%	5.4 $\mu$ Vrms	40	1.72GHz

(0) Simulation results

(1) Signal input: sinewave =  $200\text{mV}_{\text{eff}} / \text{"nominal gain"}$

(2) Output pulse height approx.  $200\text{mV}_{\text{P-P}}$ , input rise time 100ps

(3) measured with a HP3455A true rms voltmeter

Fig. 1.2: Comparison chart

Typical applications for the TA2000B are:

- Pre-amp for ultra fast detectors (MCP, PMT, ...)
- Oscilloscope and transient recorder pre-amp
- Photon-/Ion-counting
- Wideband signal processing

## 2. Specifications

### 2.1. Absolute maximum ratings

Supply:	(100 ms max.)	25 V
Signal input:		±1.8 V ± 140 mA
Input clamping:	(1 schottky + 1 silicon diode drop)	approx. ± 700 ... 900 mV
ESD rating:		3000 V HBM 200 V MM

### 2.2. Technical data

Voltage gain:	TA2000B-1:	non inverting, 26dB / x20
	TA2000B-2:	non inverting, 32dB / x40
	TA2000B-3:	non inverting, 38dB / x80
Input connector:		BNC, 50 Ohm, DC coupled AC coupling option available
Output connector:		BNC, low impedance, DC coupled 50 Ohm output option available
Output voltage:		max. ±1.3 V
Output current:		max. ±150 mA
Small signal bandwidth <sup>1</sup> :	TA2000B-1:	2000 MHz
	TA2000B-2:	1700 MHz
	TA2000B-3:	1500 MHz
Slew rate:	(2 V step)	5500 V/μs
Input offset voltage:		max. 5.75 mV typ. ±20 μV/°C
Input offset adjustment:		> ±6 mV
Input referred noise <sup>2</sup> :	TA2000B-1:	3.7 μV <sub>RMS</sub>
	TA2000B-2:	4.0 μV <sub>RMS</sub>
	TA2000B-3:	5.4 μV <sub>RMS</sub>
Noise figure:	(100 MHz)	typ. 17 dB

---

<sup>1</sup> V<sub>OUT</sub> = 200mV<sub>RMS</sub>

<sup>2</sup> measured with a HP3455A true rms voltmeter (20 Hz ... 1 MHz)

## 2.3. Diagrams

### 2.3.1. TA2000B-1 (x20) pulse response

#### Small signal pulse response (200mV<sub>P-P</sub> output)

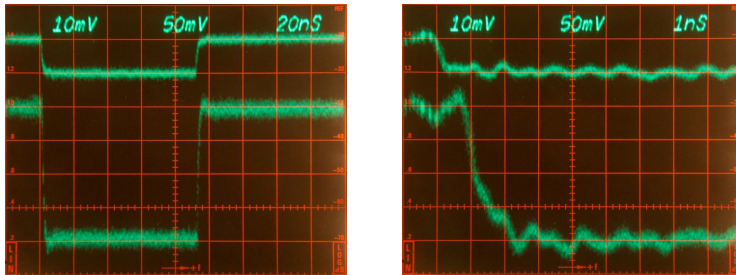

Fig. 2.1: TA2000B-1, (0Ω , 200mV<sub>P-P</sub> output)

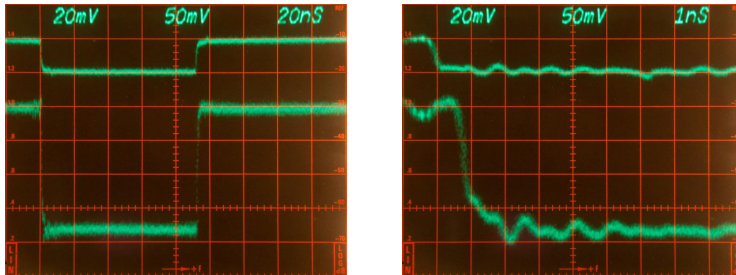

Fig. 2.2: TA2000B-1 (50Ω option, 200mV<sub>P-P</sub> output)

#### Large signal pulse response (800mV<sub>P-P</sub> negative output)

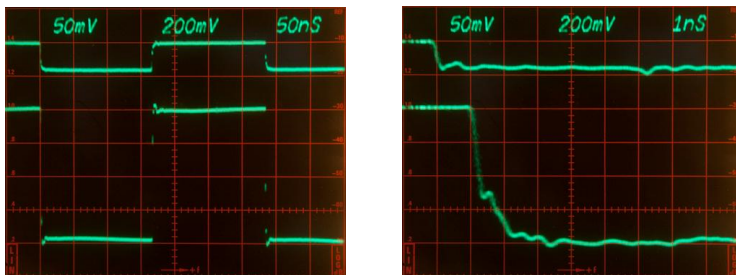

Fig. 2.3: TA2000B-1 (0Ω, 800mV<sub>P-P</sub> negative output pulse)

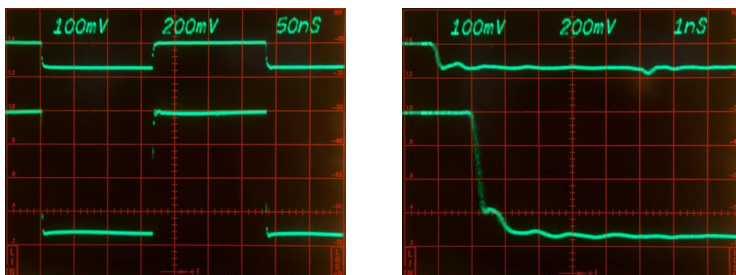

Fig. 2.4: TA2000B-1 (50Ω option, 800mV<sub>P-P</sub> negative output pulse)



### 2.3.2. TA2000B-2 (x40) pulse response

#### Small signal pulse response (200mV<sub>P-P</sub> output)

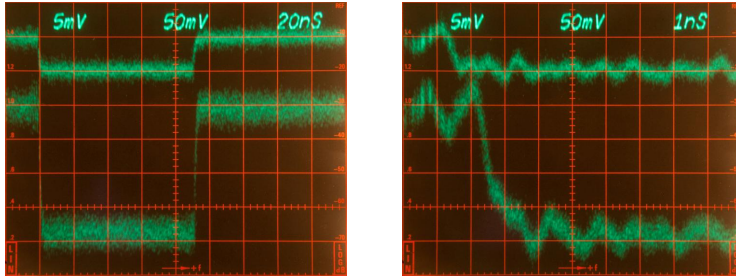

Fig. 2.5: TA2000B-2 (0Ω, 200mV<sub>P-P</sub> output)

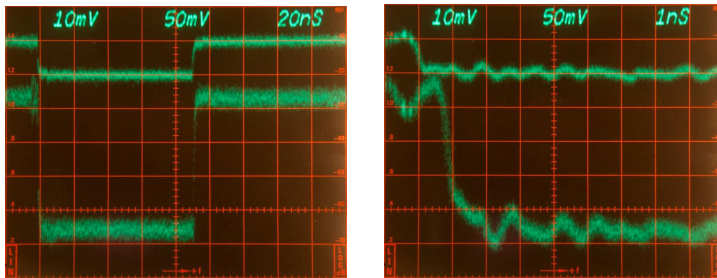

Fig. 2.6: TA2000B-2 (50Ω option, 200mV<sub>P-P</sub> output)

#### Large signal pulse response (800mV<sub>P-P</sub> negative output)

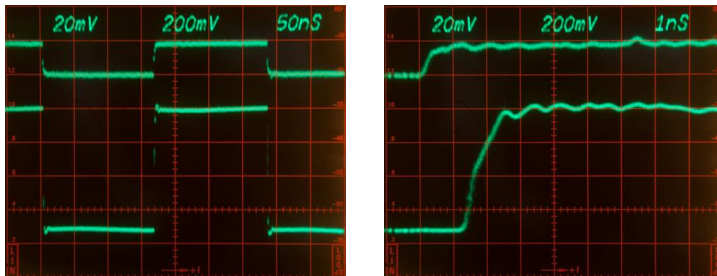

Fig. 2.7: TA2000B-2 (0Ω, 800mV<sub>P-P</sub> negative pulse)

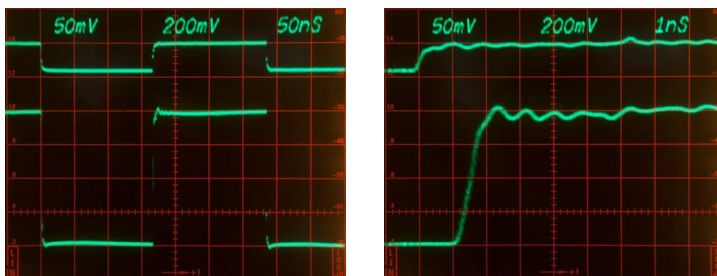

Fig. 2.8: TA2000B-2 (50Ω option, 800mV<sub>P-P</sub> negative output pulse)

### 2.3.3. TA2000B-3 (x80) pulse response

#### Small signal pulse response (200mV<sub>P-P</sub> output)

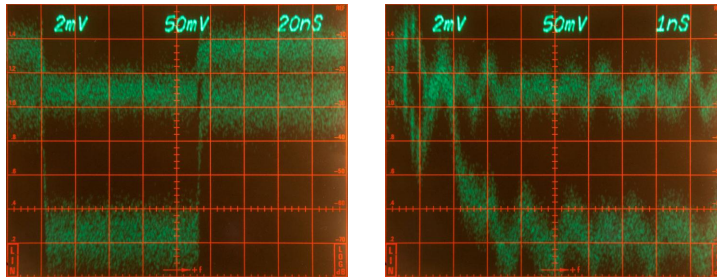

Fig. 2.9: TA2000B-3 (0Ω, 200mV<sub>P-P</sub> output)

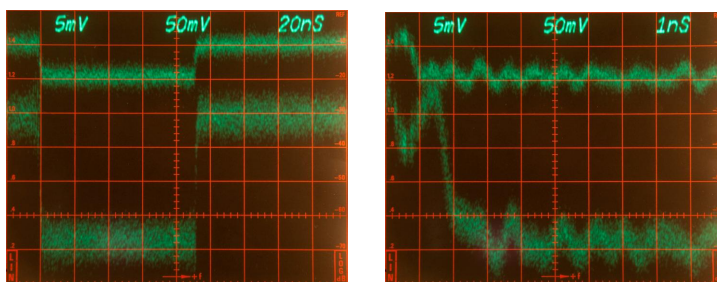

Fig. 2.10: TA2000B-3 (50Ω option, 200mV<sub>P-P</sub> output)

#### Large signal pulse response (800mV<sub>P-P</sub> negative output)

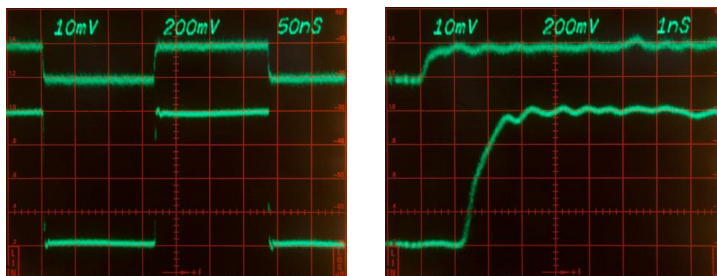

Fig. 2.11: TA2000B-3 (0Ω, 800mV<sub>P-P</sub> negative pulse)

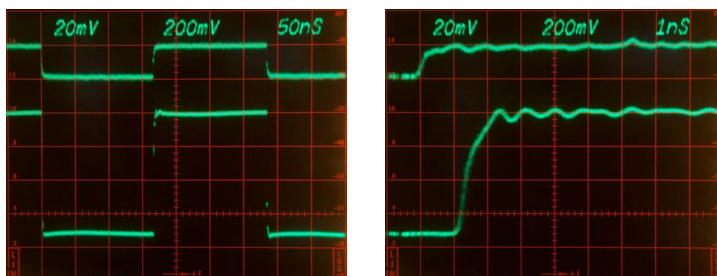

Fig. 2.12: TA2000B-3 (x50Ω option, 800mV<sub>P-P</sub> negative output pulse)

Scope pictures of input signals are taken using a 12 GHz loop-through sampling head, output signals with a 14 GHz 50Ω head

### 2.3.4. Simulated frequency response

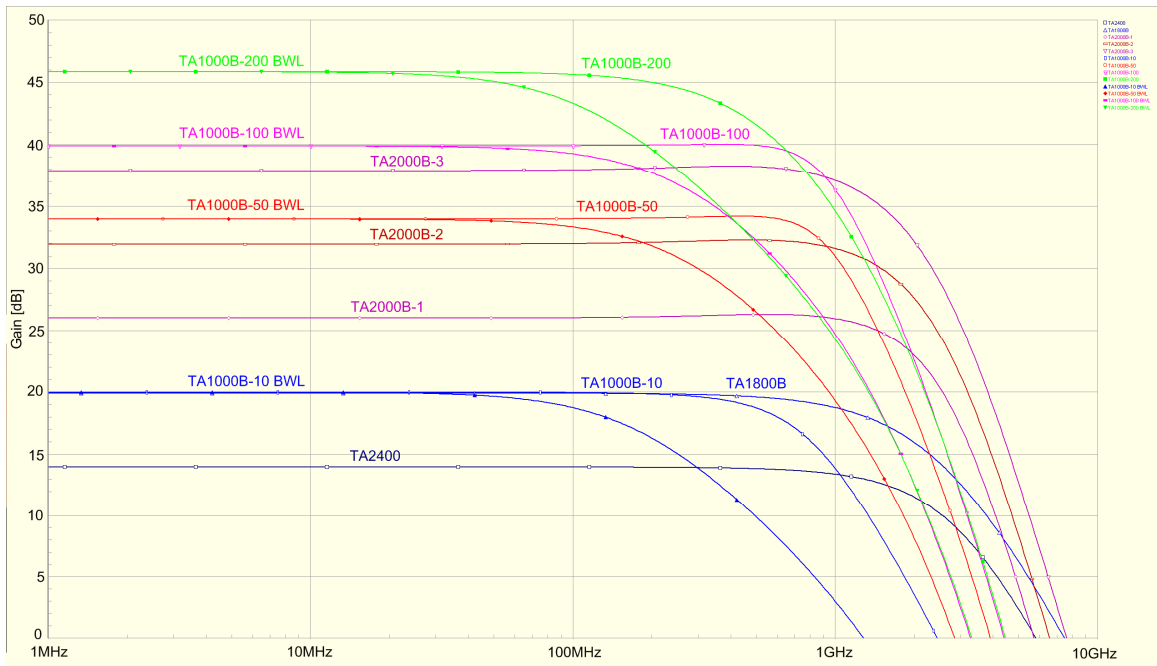

Fig. 2.13: Simulated frequency response of all TAx models

## 2.4. Power requirements

Supply connectoer:	.....2.1 mm center pin
Supply voltage:	.....nominal +12 V <sub>DC</sub>
voltage range:	.....+10 ... +18 V <sub>DC</sub>
	.....false polarity protection
Supply power:	..... 2.5 W

## 2.5. Metal case

Case material:	..... extruded aluminium sheath, Al Mg Si 0.5
Lid material:	..... die cast, GD-Al Si 12
Size:	..... 65/101 x 60 x 35 mm
Weight:	..... 124 g

## 2.6. Accessories

- External wall power supply (included)
- L-clips (order no. AB-WL) for wall-/screw-mounting (optional)

## 2.7. Available options

- **50 Ohm output impedance**  
This improves the output signal quality since reflections from the target device (oscilloscope, multichannel analyzer, etc.) are well terminated at the TA2000's output and do not travel many times back and forth over the cable. Thus, distortion of a subsequent pulse is largely avoided.  
This option is particularly recommended when high pulse rates are expected.  
The drawback, of course, is a reduction in the receiving amplitude at the target device by a factor of 2. Or, in other words, the effective voltage gain into a 50Ω load is reduced by a factor of 2 (-6 dB).
- **Input AC coupling**  
An input AC coupling with 100nF can be ordered. This results in a lower frequency cut-off of approx. 32 kHz.